

# JVC

## SERVICE MANUAL

### COLOUR TELEVISION

BASIC CHASSIS

CL-M

# AV-21F8(BK)

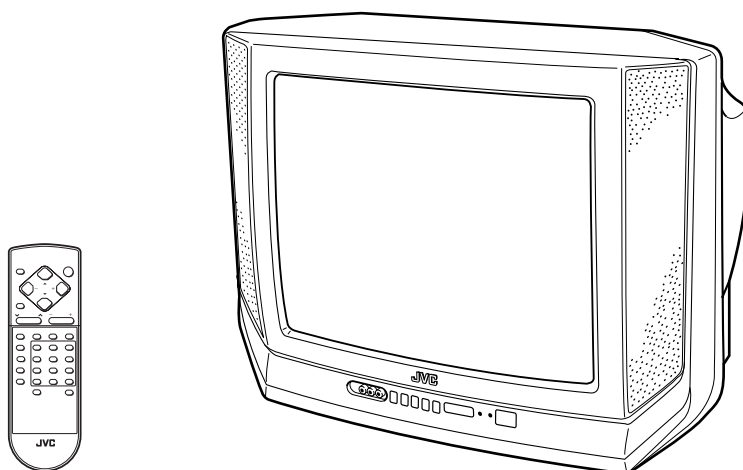

## CONTENTS

■ SPECIFICATIONS .....	2
■ SAFETY PRECAUTIONS .....	3
■ FEATURES .....	4
★ OPERATING INSTRUCTIONS (APPENDED) .....	1-1
■ SPECIFIC SERVICE INSTRUCTIONS .....	4
■ SERVICE ADJUSTMENTS .....	10
★ STANDARD CIRCUIT DIAGRAM (APPENDED) .....	2-1
■ PARTS LIST .....	27

# SPECIFICATIONS

Item		Content
<b>Dimensions (W × H × D)</b>		619mm × 458mm × 486.5mm
<b>Mass</b>		22kg
<b>TV RF System</b>		B / G, I, D / K, K1, M
<b>Colour System</b>	TV Mode	PAL / SECAM / NTSC3.58 / NTSC4.43
	VIDEO Mode	PAL / SECAM / NTSC3.58 / NTSC4.43
<b>Stereo System</b>		Bilingual in A2
<b>Receiving Frequency</b>	VHF (VL)	46.25MHz ~ 168.25MHz
	VHF (VH)	175.25MHz ~ 463.25MHz
	UHF	471.25MHz ~ 863.25MHz
	CATV	● Cable TVs of Mid (X-Z, S1-S10) Super (S11-S20) & Hyper (S21-S41) bands receivable
<b>Intermediate Frequency</b>	VIF Carrier	38.0MHz
	SIF Carrier	31.5MHz (6.5MHz) 32.0MHz (6.0MHz) 32.5MHz (5.5MHz) 33.5MHz (4.5MHz)
<b>Colour Sub Carrier Frequency</b>		PAL (4.43MHz), SECAM (4.40625MHz / 4.25MHz) NTSC (3.58MHz / 4.43MHz)
<b>Aerial Input Terminal</b>		75Ω Unbalanced
<b>Power Input</b>		Rating: AC110 ~ 240V, 50/60Hz    Operating: AC90 ~ 260V, 50/60Hz
<b>Power Consumption</b>		110W (Max.) / 78W (Avg.)
<b>Picture Tube</b>		Visible size : 51cm measured diagonally
<b>High Voltage</b>		28kV ± 1kV (at zero beam current)
<b>Speaker</b>		6cm × 12 cm Oval type × 2
<b>Audio Output</b>		5W + 5W
<b>Input</b>	Video	1Vp-p, 75Ω
	Audio (L/R)	500mVrms (-4dBs), High impedance
<b>Output</b>	Video	1Vp-p, 75Ω
	Audio (L/R)	500mVrms (-4dBs), Low impedance
<b>Remote Control Unit</b>		RM-C219-1C (Battery size : AA/R06/UM-3 × 2)

*Design & specifications are subject to change without notice.*

# SAFETY PRECAUTIONS

- The design of this product contains special hardware, many circuits and components specially for safety purposes. For continued protection, no changes should be made to the original design unless authorized in writing by the manufacturer. Replacement parts must be identical to those used in the original circuits. Service should be performed by qualified personnel only.
- Alterations of the design or circuitry of the products should not be made. Any design alterations or additions will void the manufacturer's warranty and will further relieve the manufacturer of responsibility for personal injury or property damage resulting therefrom.
- Many electrical and mechanical parts in the products have special safety-related characteristics. These characteristics are often not evident from visual inspection nor can the protection afforded by them necessarily be obtained by using replacement components rated for higher voltage, wattage, etc. Replacement parts which have these special safety characteristics are identified in the parts list of Service manual. **Electrical components having such features are identified by shading on the schematics and by (Δ) on the parts list in Service manual.** The use of a substitute replacement which does not have the same safety characteristics as the recommended replacement part shown in the parts list of Service manual may cause shock, fire, or other hazards.
- Don't short between the LIVE side ground and ISOLATED (NEUTRAL) side ground or EARTH side ground when repairing.**  
Some model's power circuit is partly different in the GND. The difference of the GND is shown by the LIVE : (⊥) side GND, the ISOLATED (NEUTRAL) : (↷) side GND and EARTH : (⊕) side GND. Don't short between the LIVE side GND and ISOLATED (NEUTRAL) side GND or EARTH side GND and never measure with a measuring apparatus (oscilloscope etc.) the LIVE side GND and ISOLATED (NEUTRAL) side GND or EARTH side GND at the same time.  
If above note will not be kept, a fuse or any parts will be broken.
- If any repair has been made to the chassis, it is recommended that the B1 setting should be checked or adjusted (See ADJUSTMENT OF B1 POWER SUPPLY).
- The high voltage applied to the picture tube must conform with that specified in Service manual. Excessive high voltage can cause an increase in X-Ray emission, arcing and possible component damage, therefore operation under excessive high voltage conditions should be kept to a minimum, or should be prevented. If severe arcing occurs, remove the AC power immediately and determine the cause by visual inspection (incorrect installation, cracked or melted high voltage harness, poor soldering, etc.). To maintain the proper minimum level of soft X-Ray emission, components in the high voltage circuitry including the picture tube must be the exact replacements or alternatives approved by the manufacturer of the complete product.
- Do not check high voltage by drawing an arc. Use a high voltage meter or a high voltage probe with a VTVM. Discharge the picture tube before attempting meter connection, by connecting a clip lead to the ground frame and connecting the other end of the lead through a 10kΩ 2W resistor to the anode button.
- When service is required, observe the original lead dress. Extra precaution should be given to assure correct lead dress in the high voltage circuit area. Where a short circuit has occurred, those components that indicate evidence of overheating should be replaced. Always use the manufacturer's replacement components.

## 9. Isolation Check

### (Safety for Electrical Shock Hazard)

After re-assembling the product, always perform an isolation check on the exposed metal parts of the cabinet (antenna terminals, video/audio input and output terminals, Control knobs, metal cabinet, screw heads, earphone jack, control shafts, etc.) to be sure the product is safe to operate without danger of electrical shock.

#### (1) Dielectric Strength Test

The isolation between the AC primary circuit and all metal parts exposed to the user, particularly any exposed metal part having a return path to the chassis should withstand a voltage of 3000V AC (r.m.s.) for a period of one second.

(. . . Withstand a voltage of 1100V AC (r.m.s.) to an appliance rated up to 120V, and 3000V AC (r.m.s.) to an appliance rated 200V or more, for a period of one second.)

This method of test requires a test equipment not generally found in the service trade.

#### (2) Leakage Current Check

Plug the AC line cord directly into the AC outlet (do not use a line isolation transformer during this check.). Using a "Leakage Current Tester", measure the leakage current from each exposed metal part of the cabinet, particularly any exposed metal part having a return path to the chassis, to a known good earth ground (water pipe, etc.). Any leakage current must not exceed 0.5mA AC (r.m.s.).

However, in tropical area, this must not exceed 0.2mA AC (r.m.s.).

#### ● Alternate Check Method

Plug the AC line cord directly into the AC outlet (do not use a line isolation transformer during this check.). Use an AC voltmeter having 1000 ohms per volt or more sensitivity in the following manner. Connect a 1500Ω 10W resistor paralleled by a 0.15μF AC-type capacitor between an exposed metal part and a known good earth ground (water pipe, etc.). Measure the AC voltage across the resistor with the AC voltmeter. Move the resistor connection to each exposed metal part, particularly any exposed metal part having a return path to the chassis, and measure the AC voltage across the resistor. Now, reverse the plug in the AC outlet and repeat each measurement. Any voltage measured must not exceed 0.75V AC (r.m.s.). This corresponds to 0.5mA AC (r.m.s.).

However, in tropical area, this must not exceed 0.3V AC (r.m.s.). This corresponds to 0.2mA AC (r.m.s.).

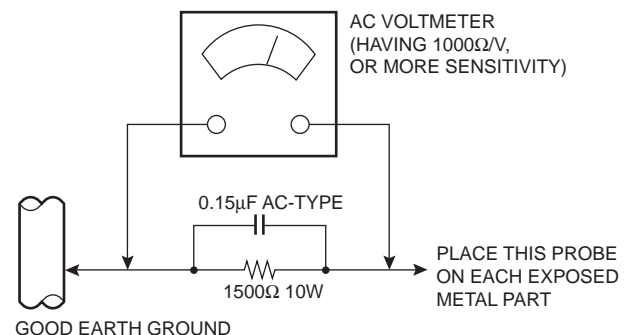

# FEATURES

- New chassis design enables use of an interactive on-screen control.
- Wide range voltage for AC power input.
- With AUDIO / VIDEO INPUT & OUTPUT terminals.
- MUTING button can reduce the audio level to zero instantly.
- Functional remote control to operate TV set (for channel select, volume control, power ON/OFF, etc.) from a distance.
- I<sup>2</sup>C bus control utilizes single chip ICs for IF, V/C (Video/Chroma) and VSM (Video Status Memory).
- By means of AUTO PROGRAM, the TV stations can be selected automatically and the TV channels can also be rearranged automatically.
- Built-in ECO MODE (ECONOMY, ECOLOGY)  
In accordance with the brightness in a room, the brightness and/or contrast of the picture can be adjusted automatically to make the optimum picture which is easy on the eye.
- Built-in ON TIMER & RETURN +.

# SPECIFIC SERVICE INSTRUCTIONS

## DISASSEMBLY PROCEDURE

### REMOVING THE REAR COVER

1. Unplug the AC power cord.
2. Remove the 6 screws marked "A" and 2 screws marked "B".
3. Withdraw the rear cover backward.

### REMOVING THE MAIN PW BOARD

- After removing the rear cover.
1. Slightly raise both sides of the Main PW Board by hand and withdraw it backward.  
(If necessary, take off the wire clamp, connectors etc.)

### REMOVING THE SPEAKER

- After removing the rear cover.
1. Remove the 2 screws marked "C".
  2. Follow the same step for removing the other hand speaker.

### CHECKING THE MAIN PW BOARD

To check the back side of the Main PW Board, follow the next steps.

1. Pull out the Main PW Board. (Refer to "REMOVING THE MAIN PW BOARD".)
2. Erect the Main PW Board vertically so that you can easily check its back side.

#### CAUTION:

- When erecting the Main PW Board, be careful so that there will be no contacting with other PW Board.
- Before turning on power, make sure that all connectors are properly connected.

### WIRE CLAMPING AND CABLE TYING

1. Be sure to clamp the wire.
2. Never remove the cable tie used for tying the wires together.  
Should it be inadvertently removed, be sure to tie the wires with a new cable tie.

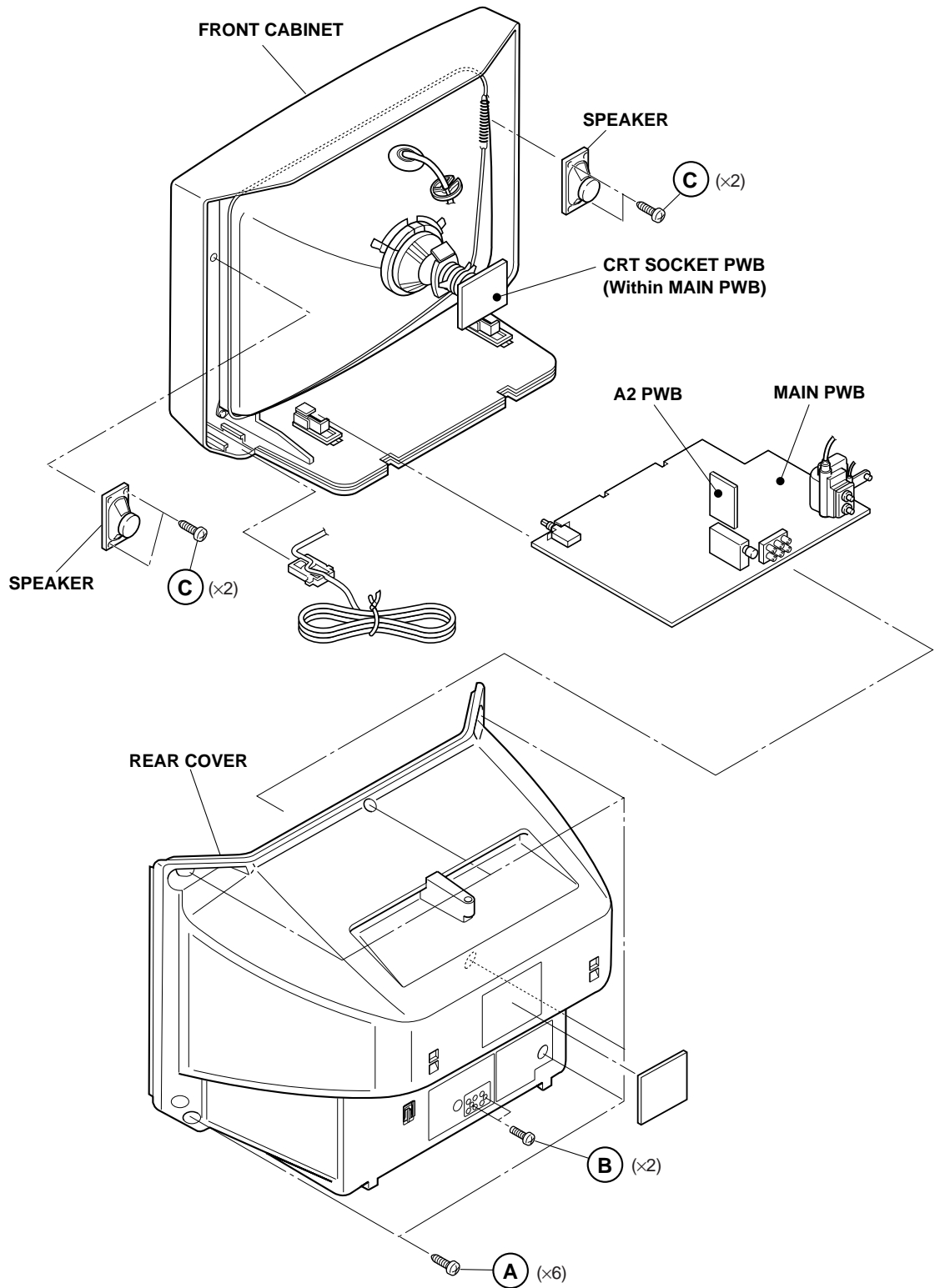

# REPLACEMENT OF MEMORY IC

## 1. MEMORY IC

This TV uses the following memory IC.

### Memory IC: IC1702 on MAIN PW Board

The memory IC memorizes data for correctly operating the video and deflection circuits. When replacing the memory IC, be sure to use the same type IC written with the initial values of data. In other words, use the specific IC listed in "PRINTED WIRING BOARD PARTS LIST". For its mounting location, refer to "ADJUSTMENT LOCATIONS".

## 2. PROCEDURE FOR REPLACING MEMORY IC

### (1) Power off

Switch the power off and unplug the power cord from the wall outlet.

### (2) Replacing the memory IC

Replace the memory IC with new one. Be sure to use the memory IC written with the initial data values.

### (3) Power on

Plug the power cord into the wall outlet and switch the power on.

### (4) Check and setting of SYSTEM CONSTANT SET:

- 1) Press the DISPLAY key and the PICTURE MODE key on the remote control unit simultaneously. The SERVICE MENU screen will be displayed. (See Fig. 1.)
- 2) In the SERVICE MENU, press the DISPLAY key and PICTURE MODE key simultaneously. Then, the SYSTEM CONSTANT SET screen will be displayed. (See Fig. 2.)
- 3) Check whether the setting values of the SYSTEM CONSTANT SET are the same as those indicated in Table 1. If the value is different, select the setting item with the MENU  $\nabla/\Delta$  key, and set the correct value with the MENU - / + key.
- 4) Press the DISPLAY key twice to return to the normal screen.

### (5) Receive channel setting

Refer to the **OPERATING INSTRUCTIONS** and set the receive channels (channels preset).

### (6) User setting

Check the user setting values in Table 2, and if setting value is different, set the correct value.  
For setting, refer to the **OPERATING INSTRUCTIONS**.

### (7) Setting of SERVICE MENU

Verify the setting for each setting item in the SERVICE MENU. (See Table 3.) If readjustment is necessary, perform adjustment referring to "SERVICE ADJUSTMENTS".

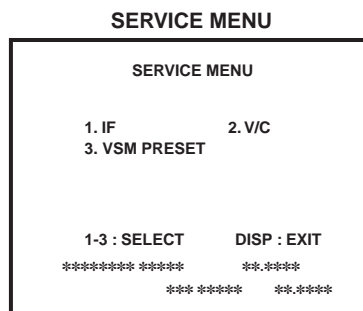

Fig. 1

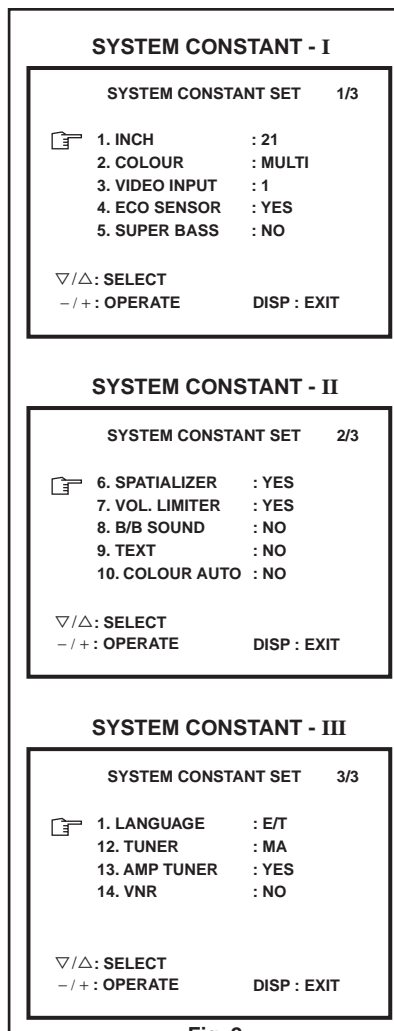
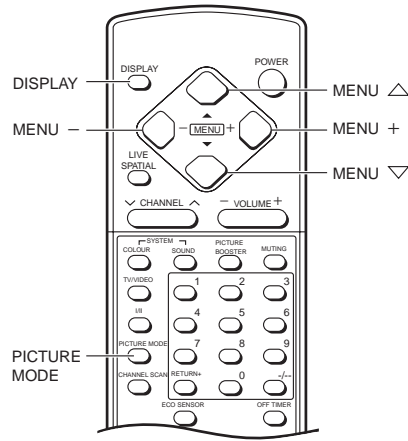

Fig. 2

**NAME OF REMOTE CONTROL KEYS**



**SETTING OF SYSTEM CONSTANT SET**

Table 1

Setting item	Setting contents	Setting value
1. INCH	▶ 29 → 25 → 21 → 14 ◻	21
2. COLOUR	▶ MULTI. → TRIPLE → PAL ◻	MULTI
3. VIDEO INPUT	▶ 1 → 3 ◻	1
4. ECO SENSOR	▶ YES → NO ◻	YES
5. SUPER BASS	▶ YES → NO ◻	NO
6. SPATIALIZER	▶ YES → NO ◻	YES
7. VOL. LIMITER	▶ YES → NO ◻	YES
8. B/B SOUND	▶ YES → NO ◻	NO
9. TEXT	▶ YES → NO ◻	NO
10. COLOUR AUTO	▶ YES → NO ◻	NO
11. LANGUAGE	▶ E → E/T ◻	E/T
12. TUNER	▶ MU → MA ◻	MA
13. AMP TUNER	▶ YES → NO ◻	YES
14. VNR	▶ YES → NO ◻	NO

**USER SETTING VALUES**

Table 2

Setting item	Setting value	Setting item	Setting value
SUB POWER	ON	TREBLE	CENTER
CHANNEL POSITION	1 POSITION	BASS	CENTER
CHANNEL PRESET	Refer to OPERATING INSTRUCTION.	BALANCE	CENTER
VOLUME	Appropriate sound volume	OFF TIMER	OFF
TV/VIDEO	TV	AUTO SHUTOFF	OFF
ON SCREEN DISPLAY	POSITION NUMBER DISPLAY	ECO SENSOR	OFF
COLOUR SYSTEM	PAL	LANGUAGE	THAI
SOUND SYSTEM	B / G	BLUE BACK	OFF
BILINGUAL MODE	I	ON TIMER	PR1 0:00
PICTURE MODE (VSM)	BRIGHT	CHILD LOCK	OFF
LIVE SPATIAL	OFF	PICTURE BOOSTER	OFF

SERVICE MENU SETTING ITEMS

Table 3

Service menu	Setting item	Service menu	Setting item
1. IF	1. VCO 2. DELAY POINT	3. VSM PRESET (BRIGHT/STD/SOFT)	TINT COLOUR BRIGHT CONT. SHARP <div style="text-align: center; margin-top: 10px;"> <span style="border: 1px solid black; padding: 2px;">Do not adjust.</span> </div>
2. V / C	1. CUTOFF(R/G/B) 2. DRIVE(R/B) 3. BRIGHT 4. CONT. 5. COLOUR 6. TINT (TV/VIDEO) 7. BLACK OFFSET(R-Y/B-Y) 8. SHARP 9. TEXT(RGB)CONT. 10. H. CENTER 11. V. HEIGHT 12. V. LIN 13. V.S-CR 14. V. CENTER 15. AMP T. SHARP <div style="text-align: center; margin-top: 10px;"> <span style="border: 1px solid black; padding: 2px;">Do not adjust.</span> </div>		



# REPLACEMENT OF CHIP COMPONENT

## ■ CAUTIONS

1. Avoid heating for more than 3 seconds.
2. Do not rub the electrodes and the resist parts of the pattern.
3. When removing a chip part, melt the solder adequately.
4. Do not reuse a chip part after removing it.

## ■ SOLDERING IRON

1. Use a high insulation soldering iron with a thin pointed end of it.
2. A 30W soldering iron is recommended for easily removing parts.

## ■ REPLACEMENT STEPS

### 1. How to remove Chip parts

#### ● Resistors, capacitors, etc.

- (1) As shown in the figure, while pushing the chip part with tweezers, alternately melt the solder at its each end.

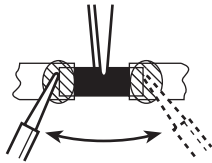

- (2) Shift the chip part with tweezers and remove it.

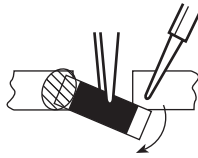

#### ● Transistors, diodes, variable resistors, etc.

- (1) Apply extra solder to each lead.



- (2) As shown in the figure, while pushing the chip part with tweezers, alternately melt the solder at its each lead. Then, shift and remove the chip part.

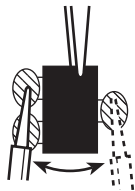

*Note : After removing the part, remove remaining solder from the pattern.*

### 2. How to install Chip parts

#### ● Resistors, capacitors, etc.

- (1) Apply solder to the pattern as indicated in the figure.

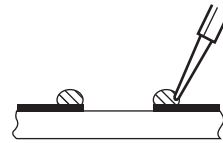

- (2) Grasp the chip part with tweezers and place it on the solder. Then heat and melt the solder at both ends of the chip part.

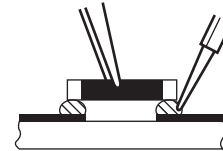

#### ● Transistors, diodes, variable resistors, etc.

- (1) Apply solder to the pattern as indicated in the figure.
- (2) Grasp the chip part with tweezers and place it on the solder.
- (3) First solder lead **A** as indicated in the figure.

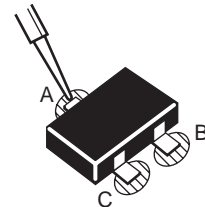

- (4) Then solder leads **B** and **C**.

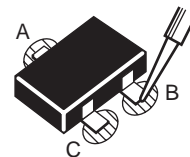

# SERVICE ADJUSTMENTS

## BEFORE STARTING SERVICE ADJUSTMENT

1. There are 2 ways for adjusting this TV: One is with the **REMOTE CONTROL UNIT** and the other is the conventional method using adjustment parts and components.
2. The setting (adjustment) using the **REMOTE CONTROL UNIT** is made on the basis of the initial setting values. The setting values which adjust the screen to the optimum condition can be different from the initial setting values.
3. Make sure that connection is correctly made to AC power source.
4. Turn on the power of the TV and measuring instrument for warming up for at least 30 minutes before starting adjustment.
5. If the receive or input signal is not specified, use the most appropriate signal for adjustment.
6. Never touch parts (such as variable resistors, transformers and capacitors) not shown in the adjustment items of this service adjustment.

7. Preparation for adjustment (presetting):

Unless otherwise specified in the adjustment items, preset the following functions with the remote control unit.

Function	Setting value
PICTURE MODE (VSM)	BRIGHT
COLOUR/BRIGHT/CONT./SHARP	See "VSM Preset" on page 23.
OFF TIMER	OFF
ECO SENSOR	OFF
BLUE BACK	OFF
PICTURE BOOSTER	OFF

## MEASURING INSTRUMENT AND FIXTURES

1. DC voltmeter (or Digital voltmeter)
2. Oscilloscope
3. Signal generator (Pattern generator)  
[PAL / SECAM / NTSC]
4. Remote control unit

## ADJUSTMENT/CHECK ITEMS

Adjustment/Check item	Page
B1 POWER SUPPLY Check	14
FOCUS Adjustment	14
IF CIRCUIT Adjustment	14
V/C (VIDEO/CHROMA) CIRCUIT Adjustment	15
DEFLECTION CIRCUIT Adjustment	21
VSM PRESET Adjustment	23
A2 SIF/DET Adjustment	23
PURITY, CONVERGENCE Adjustment	24

## BASIC OPERATION IN SERVICE MENU

### 1. TOOL OF SERVICE MENU OPERATION

Operate the SERVICE MENU with the remote control unit.

### 2. SERVICE MENU ITEMS

With the SERVICE MENU, various settings (adjustments) can be made, and they are broadly classified in the following items of settings:

- 1. IF ..... For entering/adjusting the setting values (adjustment values) of the IF circuit.
- 2. V/C ..... For entering/adjusting the setting values (adjustment values) of the VIDEO/CHROMA and DEFLECTION circuits.
- 3. VSM PRESET ..... For setting the values of STANDARD, SOFT and BRIGHT (VSM: video status memory)

3. BASIC OPERATION IN SERVICE MENU

(1) How to enter SERVICE MENU

Press the DISPLAY key and the PICTURE MODE key on the remote control unit simultaneously.  
The SERVICE MENU screen will be displayed. (See Fig. 1.)

(2) Selection of SUB MENU SCREEN

Press one of the keys 1 ~ 3 on the remote control unit, and select the SUB MENU SCREEN from the SERVICE MENU. (See Fig. 2.)

SERVICE MENU → SUB MENU

- 1. IF
- 2. V / C
- 3. VSM PRESET

SERVICE MENU

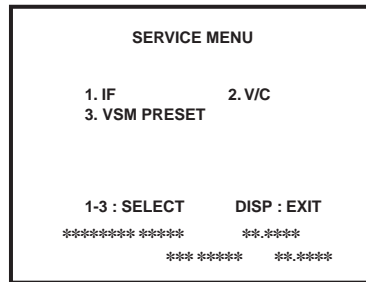

Fig. 1

SUB MENU SCREEN

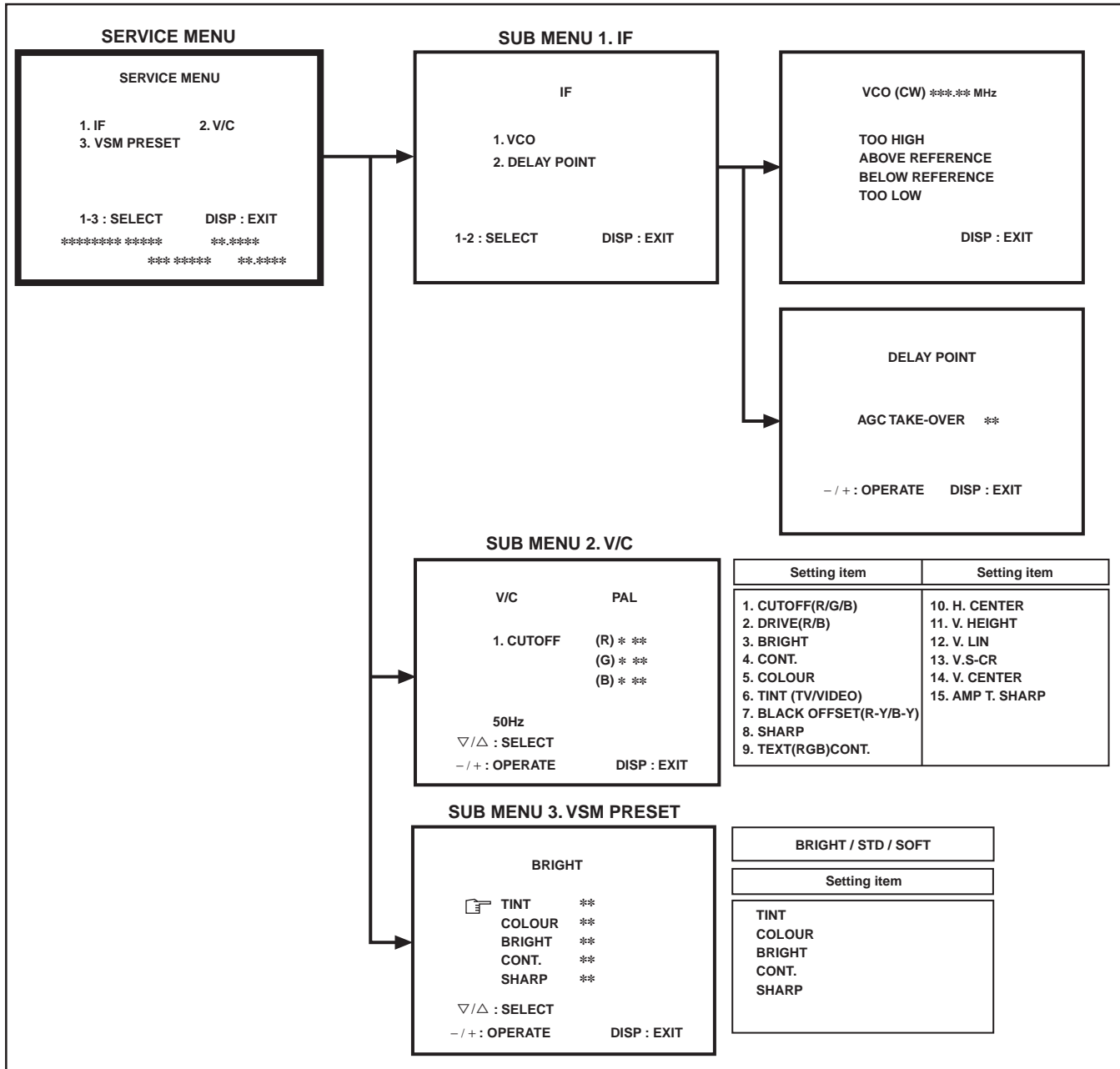

Fig. 2

**(3) Method of Setting**

\*Once the setting values are set, they are memorized automatically.

\*It must not adjust without inputting a signal.

**1) 1. IF****[1. VCO]**

- (a) 1 Key ..... Select **1. IF**.
- (b) 1 Key ..... Select 1. VCO. (CW)
- (c) VCO(CW) TRANSF. .... Adjust VCO(CW) while watching the colour (yellow/blue) of the characters on the screen.
- (d) DISPLAY Key ..... When this is pressed twice, you will return to the SERVICE MENU.

**[2. DELAY POINT]**

- (a) 1 Key ..... Select **1. IF**.
- (b) 2 Key ..... Select 2. DELAY POINT.
- (c) MENU - / + Key ..... Adjust the setting value.
- (d) DISPLAY Key ..... When this is pressed twice, you will return to the SERVICE MENU.

**2) 2. V/C and 3. VSM PRESET**

- (a) 2 and 3 Keys ..... Select **2. V/C and 3. VSM PRESET**.
- (b) MENU ▽/△ key ..... Select setting items.
- (c) MENU - / + Key ..... Adjust the setting values of the setting items.
  - Use the number keys on the remote control unit for setting of WHITE BALANCE and BLACK OFFSET. For the setting, refer to each item concerned.
- (d) DISPLAY Key ..... When this is pressed, you will return to the SERVICE MENU.

**(4) Release of SERVICE MENU**

After completing the setting, return to the SERVICE MENU by pressing the DISPLAY key, then again press the DISPLAY key to return to the normal screen.

# ADJUSTMENT LOCATIONS

## MAIN PWB

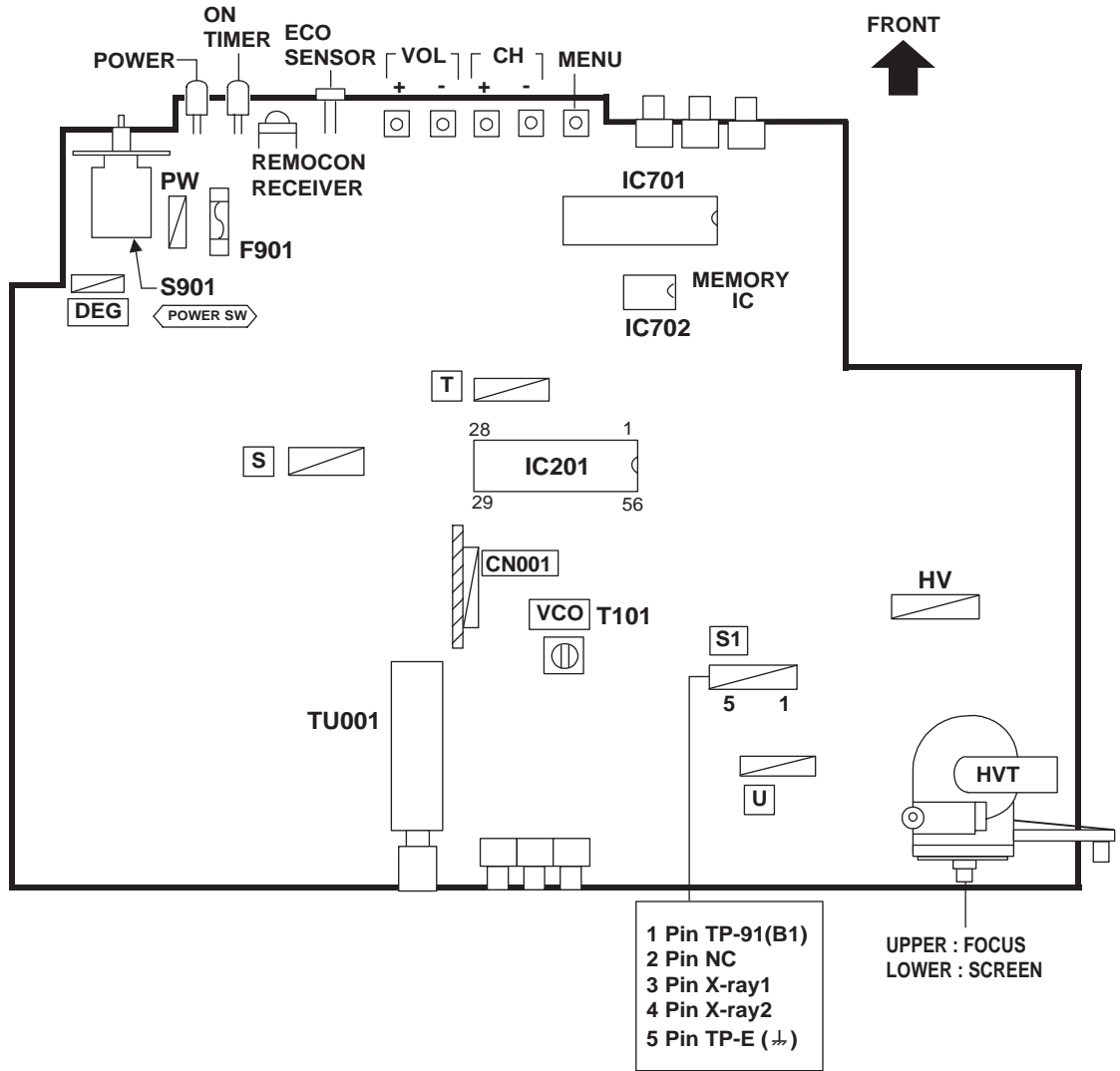

## A2 PWB

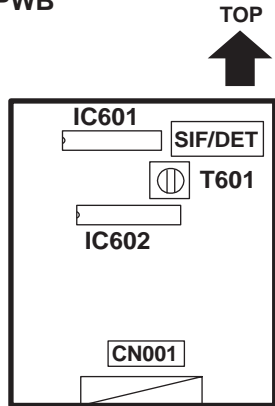

## CRT SOCKET PWB (SOLDER SIDE)

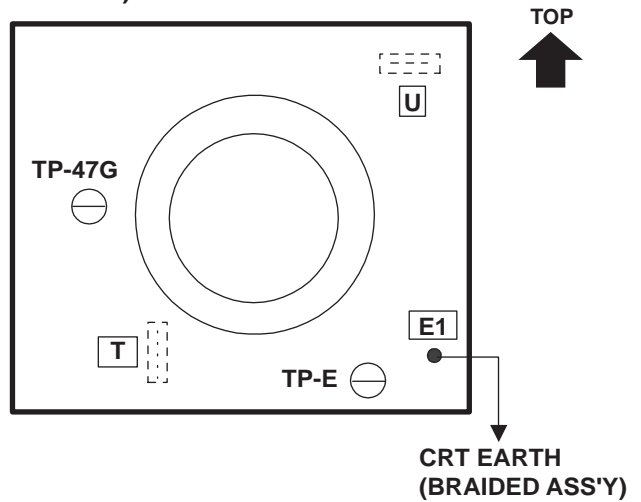

# ADJUSTMENTS

## B1 POWER SUPPLY

Item	Measuring instrument	Test point	Adjustment part	Description
Check of B1 POWER SUPPLY	Signal Generator DC Voltmeter	TP-91 (B1) TP-E (↗) [S1 connector]		<ol style="list-style-type: none"> <li>1. Receive a whole black signal.</li> <li>2. Connect a DC voltmeter between TP-91 (B1) and TP-E (↗) (between pins 1 and 5 of the connector S1).</li> <li>3. Make sure that the voltage is <b>DC114.5 ± 1.5V</b>.</li> </ol>

## FOCUS ADJUSTMENT

Item	Measuring instrument	Test point	Adjustment part	Description
Adjustment of FOCUS	Signal generator		FOCUS VR [In HVT]	<ol style="list-style-type: none"> <li>1. Receive a cross-hatch signal.</li> <li>2. While watching the screen, adjust the FOCUS VR to make the vertical and horizontal lines as fine and sharp as possible.</li> <li>3. Make sure that, when the screen is darkened, the lines remain in good focus.</li> </ol>

## IF CIRCUIT ADJUSTMENT

Item	Measuring instrument	Test point	Adjustment part	Description
Adjustment of VCO (CW)	Remote control unit		VCO (CW) TRANSF. [MAIN PWB]	<p>● <b>Under normal conditions, no adjustment is required.</b></p> <ol style="list-style-type: none"> <li>1. Select <b>1. IF</b> from the SERVICE MENU.</li> <li>2. Press the <b>1</b> key to select <b>1. VCO</b>.</li> <li>3. Select a receivable broadcast channel with the CHANNEL key.</li> <li>4. Turn the core of VCO(CW) TRANSF. until the colour of the characters "TOO HIGH" displayed on the screen changes from blue to <b>yellow</b>. (Step 1)</li> <li>5. Then slowly turn the core of VCO(CW) TRANSF. counterclockwise until the characters "ABOVE REFERENCE" changes from blue to <b>yellow</b>. (Step 2)</li> <li>6. Further slowly turn the core of VCO(CW) TRANSF. until the colour of the characters "BELOW REFERENCE" changes from blue to <b>yellow</b>. (Step 3)</li> <li>7. Press the DISPLAY key three times to return to normal screen.</li> <li>8. Perform CHANNEL PRESET again, and make sure that each broadcast is being received properly.</li> </ol>

Screen display	Step		
	1 →	2 →	3
TOO HIGH	<b>Yellow</b> →	Blue →	Blue
ABOVE REFERENCE	Blue →	<b>Yellow</b> →	Blue
BELOW REFERENCE	Blue →	Blue →	<b>Yellow</b>
TOO LOW	Blue →	→	Blue

Item	Measuring instrument	Test point	Adjustment part	Description		
Adjustment of DELAY POINT	Remote control unit		DELAY POINT (AGC TAKE-OVER)	<ol style="list-style-type: none"> <li>1. Receive a black and white signal (colour off).</li> <li>2. Select <b>1. IF</b> from the SERVICE MENU.</li> <li>3. Select <b>2. DELAY POINT</b> by pressing the <b>2</b> key on the remote control.</li> <li>4. Adjust the MENU – or + key until video noise disappears.</li> <li>5. Press the DISPLAY key three times to return to the normal screen.</li> <li>6. Turn to other channels and make sure that there are no irregularities.</li> </ol>		
					<table border="1"> <thead> <tr> <th>Setting (Adjustment) item</th> <th>Variable range</th> <th>Initial setting value</th> </tr> </thead> <tbody> <tr> <td>DELAY POINT (AGC TAKE-OVER)</td> <td>0 ~ 63</td> <td>20</td> </tr> </tbody> </table>	Setting (Adjustment) item
Setting (Adjustment) item	Variable range	Initial setting value				
DELAY POINT (AGC TAKE-OVER)	0 ~ 63	20				

## V/C (VIDEO/CHROMA) CIRCUIT ADJUSTMENT

The setting (adjustment) using the remote control unit is made on the basis of the initial setting values.  
 The setting values which adjust the screen to the optimum condition can be different from the initial setting values.  
 ● Do not change the initial setting values of the setting (adjustment) items not listed in "ADJUSTMENT".

[SUB MENU 2. V/C (1. CUT OFF (R / G / B) ~ 9. TEXT (RGB) CONT. and 15. AMP SHARP)]

Setting item	Colour system	Variable range	Initial setting value			
			PAL	SECAM	NTSC 3.58	NTSC 4.43
1. CUT OFF (R / G / B)		-128 ~ +127	0	←	←	←
2. DRIVE (R / B)		-128 ~ +127	0	←	←	←
3. BRIGHT		-64 ~ +63	-11	←	←	←
4. CONT.		-58 ~ +28	-10	←	←	←
5. COLOUR		-60 ~ +67	+7	+11	+12	-2
6. TINT	TV / VIDEO	-64 ~ +63	—	—	+5 / 0	-2 / 0
7. BLACK OFFSET (R-Y / B-Y)		-8 ~ +7	—	0 / 0	—	—
8. SHARP	TV / VIDEO	-32 ~ +31	+10 / +8	←	←	←
9. TEXT (RGB) CONT.		-128 ~ +127	+15	←	←	←
15. AMP T. SHARP		-128 ~ +127	-15	←	←	←

 : Do not adjust.

Item	Measuring instrument	Test point	Adjustment part	Description										
<p><b>Adjustment of WHITE BALANCE (Low light)</b></p>	<ul style="list-style-type: none"> <li>● Signal generator</li> <li>● Remote control unit</li> </ul>		<p><b>1. CUTOFF (R) CUTOFF (G) CUTOFF (B)</b></p> <p><b>SCREEN VR (In HVT)</b></p>	<ol style="list-style-type: none"> <li>1. Receive a black and white signal (colour off).</li> <li>2. Select <b>2. V/C</b> from the SERVICE MENU.</li> <li>3. Select <b>1. CUTOFF (R), (G) and (B)</b> with MENU <math>\nabla/\Delta</math> key, and set each value to initial setting value with <b>4 ~ 9</b> keys on the remote control unit.</li> <li>4. Press the <b>1</b> key on the remote control unit to produce a single horizontal line.</li> <li>5. Turn the SCREEN VR fully counterclockwise, then slowly turn it clockwise to where a red, blue, or green colour is faintly visible.</li> <li>6. Use keys <b>4 ~ 9</b> on the remote control unit and adjust the other 2 colours to where the single horizontal line appears white.</li> <li>7. Turn the SCREEN VR to where the single horizontal line glows faintly.</li> <li>8. Press the <b>2</b> key to return to <b>1. CUTOFF</b> screen.</li> <li>9. Press the DISPLAY key twice to return to the normal screen.</li> </ol> <table border="1" data-bbox="797 772 1398 989" style="width: 100%; border-collapse: collapse; margin-top: 20px;"> <thead> <tr> <th style="width: 30%;">Setting (Adjustment) item</th> <th style="width: 30%;">Variable range</th> <th style="width: 40%;">Initial setting value</th> </tr> </thead> <tbody> <tr> <td rowspan="3">1. CUT OFF</td> <td>R</td> <td>-128 ~ +127</td> </tr> <tr> <td>G</td> <td>-128 ~ +127</td> </tr> <tr> <td>B</td> <td>-128 ~ +127</td> </tr> </tbody> </table>	Setting (Adjustment) item	Variable range	Initial setting value	1. CUT OFF	R	-128 ~ +127	G	-128 ~ +127	B	-128 ~ +127
Setting (Adjustment) item	Variable range	Initial setting value												
1. CUT OFF	R	-128 ~ +127												
	G	-128 ~ +127												
	B	-128 ~ +127												
<p><b>Adjustment of WHITE BALANCE (High light)</b></p>	<ul style="list-style-type: none"> <li>● Signal generator</li> <li>● Remote control unit</li> </ul>		<p><b>2. DRIVE (R) DRIVE (B)</b></p>	<ol style="list-style-type: none"> <li>1. Receive a black and white signal (colour off).</li> <li>2. Select <b>2. V/C</b> from the SERVICE MENU.</li> <li>3. Select <b>2. DRIVE (R) / (B)</b> with MENU <math>\nabla/\Delta</math> key, and set each value to initial setting value with <b>4</b> and <b>7</b> keys, or <b>6</b> and <b>9</b> keys on the remote control unit.</li> <li>4. Use the keys <b>4</b> and <b>7</b> or <b>6</b> and <b>9</b> to produce a white screen.</li> <li>5. Press the DISPLAY key twice to return to the normal screen.</li> </ol> <table border="1" data-bbox="797 1566 1398 1740" style="width: 100%; border-collapse: collapse; margin-top: 20px;"> <thead> <tr> <th style="width: 30%;">Setting (Adjustment) item</th> <th style="width: 30%;">Variable range</th> <th style="width: 40%;">Initial setting value</th> </tr> </thead> <tbody> <tr> <td rowspan="2">2. DRIVE</td> <td>R</td> <td>-128 ~ +127</td> </tr> <tr> <td>B</td> <td>-128 ~ +127</td> </tr> </tbody> </table>	Setting (Adjustment) item	Variable range	Initial setting value	2. DRIVE	R	-128 ~ +127	B	-128 ~ +127		
Setting (Adjustment) item	Variable range	Initial setting value												
2. DRIVE	R	-128 ~ +127												
	B	-128 ~ +127												

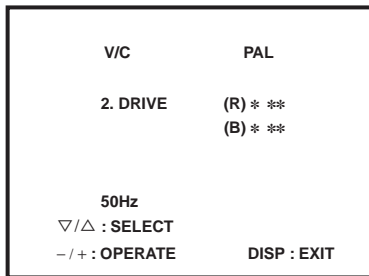
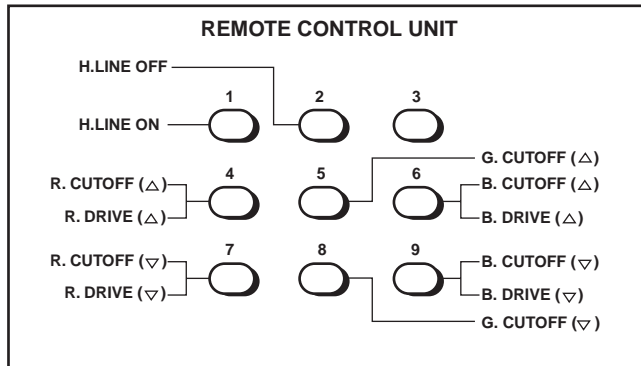
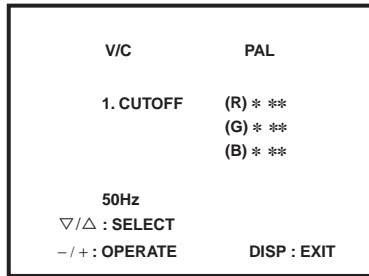



Item	Measuring instrument	Test point	Adjustment part	Description
Adjustment of SUB BRIGHT	Remote control unit		3. BRIGHT	<ol style="list-style-type: none"> <li>1. Receive any broadcast.</li> <li>2. Select <b>2. V/C</b> from the SERVICE MENU.</li> <li>3. Select <b>3. BRIGHT</b> with the MENU <math>\nabla/\Delta</math> key.</li> <li>4. Set the initial setting value with the MENU – or + key.</li> <li>5. If the brightness is not the best with the initial set value, make fine adjustment until you get the best brightness.</li> <li>6. Press the DISPLAY key twice to return to the normal screen.</li> </ol>
Adjustment of SUB CONT.	Remote control unit		4. CONT.	<ol style="list-style-type: none"> <li>1. Receive any broadcast.</li> <li>2. Select <b>2. V/C</b> from the SERVICE MENU.</li> <li>3. Select <b>4. CONT.</b> with the MENU <math>\nabla/\Delta</math> key.</li> <li>4. Set the initial setting value with the MENU – or + key.</li> <li>5. If the contrast is not the best with the initial set value, make fine adjustment until you get the best contrast.</li> <li>6. Press the DISPLAY key twice to return to the normal screen.</li> </ol>
Adjustment of SUB COLOUR-I	Remote control unit		5. COLOR	<b>[Method of adjustment without measuring instrument]</b>
			PAL COLOUR	<b>(PAL COLOUR)</b> <ol style="list-style-type: none"> <li>1. Receive a PAL broadcast.</li> <li>2. Select <b>2. V/C</b> from the SERVICE MENU.</li> <li>3. Select <b>5. COLOUR</b> with the MENU <math>\nabla/\Delta</math> key.</li> <li>4. Set the initial setting value for PAL COLOUR with the MENU – or + key.</li> <li>5. If the colour is not the best with the initial set value, make fine adjustment until you get the best colour.</li> <li>6. Press the DISPLAY key twice to return to the normal screen.</li> </ol>
			SECAM COLOUR	<b>(SECAM COLOUR)</b> <ol style="list-style-type: none"> <li>1. Receive a SECAM broadcast.</li> <li>2. Make fine adjustment of SECAM COLOUR in the same way as for "PAL COLOUR".</li> </ol>
			NTSC 3.58 COLOUR	<b>(NTSC 3.58 COLOUR)</b> <ol style="list-style-type: none"> <li>1. Receive a NTSC 3.58MHz broadcast.</li> <li>2. Make similar fine adjustment of NTSC 3.58 COLOUR in the same way as for "PAL COLOUR".</li> </ol>
				<b>(NTSC 4.43 COLOUR)</b> When adjustment is done for NTSC 3.58 COLOUR, appropriate values are automatically set for NTSC 4.43 COLOUR.

Item	Measuring instrument	Test point	Adjustment part	Description
Adjustment of SUB COLOUR-II	<ul style="list-style-type: none"> <li>● Signal generator</li> <li>● Oscilloscope</li> <li>● Remote control unit</li> </ul>	TP-47G TP-E (↗) [CRT SOCKET PWB]	5. COLOUR	[Method of adjustment using measuring instrument]
			PAL COLOUR	<p><b>(PAL COLOUR)</b></p> <ol style="list-style-type: none"> <li>1. Receive a PAL full field colour bar signal (75% white).</li> <li>2. Select <b>2. V/C</b> from the SERVICE MENU.</li> <li>3. Select <b>5. COLOUR</b> with the MENU ▽/△ key.</li> <li>4. Set the initial setting value of PAL COLOUR with the MENU – or + key.</li> <li>5. Connect the oscilloscope between TP-47G and TP-E.</li> <li>6. Adjust PAL COLOUR to set the value <b>(A)</b> in the figure to <b>+5V (W &amp; G)</b>.</li> </ol>
			SECAM COLOUR	<p><b>(SECAM COLOUR)</b></p> <ol style="list-style-type: none"> <li>1. Receive a SECAM full field colour bar signal (75% white).</li> <li>2. Set the initial setting value of SECAM COLOUR with the MENU – or + key.</li> <li>3. Adjust SECAM COLOUR to set the value <b>(A)</b> in the figure to <b>+4V (W &amp; G)</b>.</li> </ol>
			NTSC 3.58 COLOUR	<p><b>(NTSC 3.58 COLOUR)</b></p> <ol style="list-style-type: none"> <li>1. Receive a NTSC 3.58 full field colour bar signal (75% white).</li> <li>2. Set the initial setting value of NTSC 3.58 COLOUR with the MENU – or + key.</li> <li>3. Adjust NTSC 3.58 COLOUR to set the value <b>(A)</b> in the figure to <b>+3V (W &amp; G)</b>.</li> </ol>
		<p><b>(NTSC 4.43 COLOUR)</b></p> When adjustment is done for NTSC 3.58 COLOUR, appropriate values are automatically set for NTSC 4.43 COLOUR.		

Item	Measuring instrument	Test point	Adjustment part	Description
Adjustment of SUB TINT-I	Remote control unit		6. TINT	<b>[Method of adjustment without measuring instrument]</b>
			NTSC 3.58 TINT	<b>(NTSC 3.58 TINT)</b> 1. Receive a NTSC 3.58 colour bar signal (full field colour bar 75% white). 2. Select <b>2. V/C</b> from the SERVICE MENU. 3. Select <b>6. TINT</b> with the MENU ▽/△ key. 4. Set the initial setting value of NTSC 3.58 with the MENU – or + key. 5. If you cannot get the best tint with the initial setting value, make fine adjustment until you get the best tint. 6. Press the DISPLAY key twice to return to the normal screen.
				<b>(NTSC 4.43 COLOUR)</b> When adjustment is done for NTSC 3.58 TINT, appropriate values are automatically set for NTSC 4.43 TINT.
Adjustment of SUB TINT-II	<ul style="list-style-type: none"> <li>● Signal generator</li> <li>● Oscilloscope</li> <li>● Remote control unit</li> </ul>	TP-47G TP-E (↯) [CRT SOCKET PWB]	6. TINT	<b>[Method of adjustment using measuring instrument]</b>
			NTSC 3.58 TINT	<b>(NTSC 3.58 TINT)</b> 1. Receive a NTSC 3.58 colour bar signal (full field colour bar 75% white). 2. Select <b>2. V/C</b> from the SERVICE MENU. 3. Select <b>6. TINT</b> with the MENU ▽/△ key. 4. Set the initial setting value of NTSC 3.58 with the MENU – or + key. 5. Connect the oscilloscope between TP-47G and TP-E. 6. Adjust NTSC 3.58 TINT to set the value <b>(B)</b> in the figure to <b>+3V (W &amp; Cy)</b> . 7. Press the DISPLAY key twice to return to the normal screen.
				<b>(NTSC 4.43 TINT)</b> When adjustment is done for NTSC 3.58 TINT, appropriate values are automatically set for NTSC 4.43 TINT.

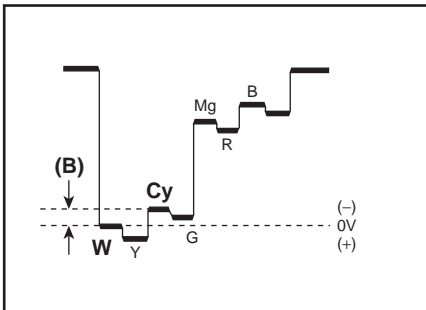

Item	Measuring instrument	Test point	Adjustment part	Description
<b>Adjustment of BLACK OFFSET-I (SECAM)</b>	Remote control unit		<b>7. BLACK OFFSET (R-Y) (B-Y)</b>	<p><b>[Method of adjustment without measuring instrument]</b></p> <ol style="list-style-type: none"> <li>1. Receive a SECAM broadcast.</li> <li>2. Select <b>2. V/C</b> from the SERVICE MENU.</li> <li>3. Select <b>7. BLACK OFFSET</b> with the MENU <math>\nabla/\Delta</math> key.</li> <li>4. Set the initial setting value for BLACK OFFSET (R-Y) and (B-Y) with <b>4</b> and <b>7</b> or <b>6</b> and <b>9</b> keys on the remote control unit.</li> <li>5. If the picture is not the best with the initial setting value, make fine adjustment until you get the best picture.</li> <li>6. Press the DISPLAY key twice to return to the normal screen.</li> </ol>
<div style="border: 1px solid black; padding: 5px; text-align: center;"> <p><b>REMOTE CONTROL UNIT</b></p> </div>				<p><b>[Method of adjustment using measuring instrument]</b></p> <ol style="list-style-type: none"> <li>1. Receive a SECAM COLOUR bar signal (full field colour bar 75% white).</li> <li>2. Select <b>2. V/C</b> from the SERVICE MENU.</li> <li>3. Select <b>7. BLACK OFFSET</b> with the <math>\nabla/\Delta</math> key.</li> <li>4. Connect the oscilloscope between pin <b>35</b> of IC 201 and TP-E.</li> <li>5. By using <b>4</b> and <b>7</b> keys on the remote control unit, adjust the BLACK OFFSET (R-Y) so that the waveform changes from <b>(a)</b> to <b>(b)</b> as shown in the figure.</li> <li>6. Connect the oscilloscope between pin <b>36</b> of IC 201 and TP-E.</li> <li>7. By using <b>6</b> and <b>9</b> keys on the remote control unit, adjust the BLACK OFFSET (B-Y) so that the waveform changes from <b>(c)</b> to <b>(d)</b> as shown in the figure.</li> <li>8. If the picture is not the best with the adjusted picture, make fine adjustment until you get the best picture.</li> <li>9. Press the DISPLAY key twice to return to the normal screen.</li> </ol>
<b>Adjustment of BLACK OFFSET-II (SECAM)</b>	<ul style="list-style-type: none"> <li>● Signal generator</li> <li>● Oscilloscope</li> <li>● Remote control unit</li> </ul>	35 PIN (R-Y) 36 PIN (B-Y) IC 201 on MAIN PWB	<b>7. BLACK OFFSET (R-Y) (B-Y)</b>	<p><b>[R-Y]</b></p> <p><b>[B-Y]</b></p>

**DEFLECTION CIRCUIT ADJUSTMENT**

- There are 2 modes of adjustment (initial setting value) — 50Hz mode and 60Hz mode — depending upon the kind of signals (vertical frequency 50Hz / 60Hz).
- When adjusted in 50Hz mode, 60Hz mode will be automatically set.

The setting (adjustment) using the remote control unit is made on the basis of the initial setting values.  
 The setting values which adjust the screen to the optimum condition can be different from the initial setting values.

[SUB MENU 2. V/C (10. H. CENTER ~ 14. V. CENTER)]

Setting item	Adjustment name	Variable range	Initial setting value	
			50Hz	60Hz
10. H. CENTER	Horizontal center	-16 ~ +15	-10	-10
11. V. HEIGHT	Vertical height	-64 ~ +63	-15	0
12. V. LIN	Vertical linearity	-16 ~ +15	0	0
13. V.S-CR	Vertical height correction	-64 ~ +63	-15	0
14. V. CENTER	Vertical center	0 ~ +127	0 (Fixed)	0 (Fixed)

: Do not adjust.

Item	Measuring instrument	Test point	Adjustment part	Description
Adjustment of V. HEIGHT	<ul style="list-style-type: none"> <li>● Signal generator</li> <li>● Remote control unit</li> </ul>		11. V. HEIGHT	<p>[ fv : 50Hz mode]</p> <ol style="list-style-type: none"> <li>1. Receive a cross-hatch signal.</li> <li>2. Select <b>2. V/C</b> from the SERVICE MENU.</li> <li>3. Select <b>11. V. HEIGHT</b> with the MENU <math>\nabla/\Delta</math> key.</li> <li>4. Set the initial setting value of <b>11. V. HEIGHT</b> with the MENU - / + key.</li> <li>5. Adjust V. HEIGHT and make the vertical screen size 92% of the picture size with the MENU - / + key.</li> </ol> <p>(to be continued)</p>

The diagram illustrates the relationship between screen size and picture size. It features a 10x10 grid of squares. A dashed line outlines the entire grid, labeled 'Screen size' at the top and 'Picture size 100%' at the bottom. A solid line outlines a smaller area within the grid, labeled 'Screen size 92%' on the left and 'Picture size 100%' on the right. This indicates that the screen size is 92% of the picture size.

Item	Measuring instrument	Test point	Adjustment part	Description
<p><b>Adjustment of H. CENTER</b></p>			<p><b>10. H. CENTER</b></p>	<p>6. Receive a circle pattern signal.            7. Select <b>10. H. CENTER</b> with the MENU <math>\nabla/\Delta</math> key.            8. Set the initial setting value of <b>10. H. CENTER</b> with the MENU <math>-/+</math> key.            9. Adjust H. CENTER to make "<b>A = B</b>" with the MENU <math>-/+</math> key.</p>
<p><b>Adjustment of V.S-CR &amp; V. LIN</b></p>			<p><b>13. V.S-CR</b>  <b>12. V. LIN</b></p>	<p>● <b>When the vertical linearity has been deteriorated remarkably, perform the following steps.</b></p> <p>10. Receive a cross-hatch signal.            11. Select <b>13. V.S-CR</b> with the MENU <math>\nabla/\Delta</math> key.            12. Set the initial setting value of <b>13. V.S-CR</b> with the MENU <math>-/+</math> key.            13. Select <b>12. V. LIN</b> with the MENU <math>\nabla/\Delta</math> key.            14. Set the initial setting value of <b>12. V. LIN</b> with the MENU <math>-/+</math> key.            15. Adjust V.S-CR and V. LIN so that the spaces of each line on TOP, CENTER and BOTTOM become uniform.</p>
				<p>16. Make sure that the adjustment is properly done on the screen of 60Hz mode.            17. Press the DISPLAY key twice to return to the normal screen.</p> <p><b>[NOTE]</b></p> <p>● When adjust in 60Hz mode, only 60Hz mode is adjust.</p>

**VSM PRESET ADJUSTMENT**

Item	Measuring instrument	Test point	Adjustment part	Description																								
Setting of VSM PRESET	Remote control unit		TINT COLOUR BRIGHT CONT. SHARP	<p>(VSM PRESET)</p> <ol style="list-style-type: none"> <li>1. Select <b>3. VSM PRESET</b> from the SERVICE MENU.</li> <li>2. Select BRIGHT with the PICTURE MODE key.</li> <li>3. Adjust the MENU <math>\nabla/\Delta</math> key and MENU - or + key to reset the set values of <b>TINT ~ SHARP</b> to the values shown in the table.</li> <li>4. Respectively select the VSM PRESET mode for SOFT and STANDARD, and make similar adjustment as in 3 above.</li> <li>5. Press the DISPLAY key twice to return to the normal screen.</li> </ol> <p><b>[Setting Values for SUB MENU 3. VSM PRESET]</b></p> <table border="1"> <thead> <tr> <th>VSM preset mode / VSM Setting item</th> <th>BRIGHT</th> <th>STANDARD</th> <th>SOFT</th> </tr> </thead> <tbody> <tr> <td>TINT SETTING VALUE</td> <td>15</td> <td>←</td> <td>←</td> </tr> <tr> <td>COLOUR SETTING VALUE</td> <td>15</td> <td>←</td> <td>←</td> </tr> <tr> <td>BRIGHT SETTING VALUE</td> <td>15</td> <td>←</td> <td>←</td> </tr> <tr> <td>CONT. SETTING VALUE</td> <td>30</td> <td>19</td> <td>14</td> </tr> <tr> <td>SHARP SETTING VALUE</td> <td>20</td> <td>←</td> <td>15</td> </tr> </tbody> </table> <p> : Do not adjust.</p>	VSM preset mode / VSM Setting item	BRIGHT	STANDARD	SOFT	TINT SETTING VALUE	15	←	←	COLOUR SETTING VALUE	15	←	←	BRIGHT SETTING VALUE	15	←	←	CONT. SETTING VALUE	30	19	14	SHARP SETTING VALUE	20	←	15
VSM preset mode / VSM Setting item	BRIGHT	STANDARD	SOFT																									
TINT SETTING VALUE	15	←	←																									
COLOUR SETTING VALUE	15	←	←																									
BRIGHT SETTING VALUE	15	←	←																									
CONT. SETTING VALUE	30	19	14																									
SHARP SETTING VALUE	20	←	15																									

**SUB MENU 3. VSM PRESET**

**BRIGHT**

 TINT   \*\*  
 COLOUR   \*\*  
 BRIGHT   \*\*  
 CONT.   \*\*  
 SHARP   \*\*

$\nabla/\Delta$  : SELECT  
 -/+ : OPERATE      DISP : EXIT

**A2 SIF/DET ADJUSTMENT**

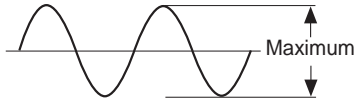
Item	Measuring instrument	Test point	Adjustment part	Description
Adjustment of A2 SIF/DET	<ul style="list-style-type: none"> <li>● Oscilloscope</li> <li>● Remote control unit</li> </ul>	Audio Output Terminal L or R	T601 [A2 PWB]	<ol style="list-style-type: none"> <li>1. Connect an oscilloscope to the Audio Output Terminal L or R on the rear of the TV.</li> <li>2. Receive a Germany Multiple sound signal.</li> <li>3. Set the TV to A2 or Bilingual mode with the I/II key on the screen display II.</li> <li>4. Turn T601 so that the audio waveform on the oscilloscope is maximum in amplitude and perpendicularly symmetrical as shown below:</li> </ol> <div style="text-align: center;">  </div>

## PURITY, CONVERGENCE ADJUSTMENT

### PURITY ADJUSTMENT

1. Demagnetize CRT with the demagnetizer.
2. Loosen the retainer screw of the deflection yoke.
3. Remove the wedges. (Fig. 1.)
4. Input a green raster signal from the signal generator, and turn the screen to green raster.
5. Move the deflection yoke backward.
6. Bring the long lug of the purity magnets on the short lug and position them horizontally. (Fig. 2)
7. Adjust the gap between two lugs so that the green raster will come into the center of the screen. (Fig. 3)
8. Move the deflection yoke forward, and fix the position of the deflection yoke so that the whole screen will become green.
9. Insert the wedge to the top side of the deflection yoke so that it will not move.
10. Input a cross-hatch signal.
11. Verify that the screen is horizontal.
12. Input red and blue raster signals, and make sure that purity is properly adjusted.

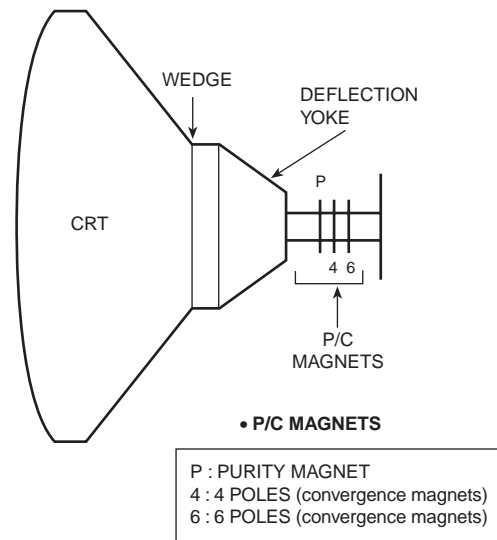

Fig. 1

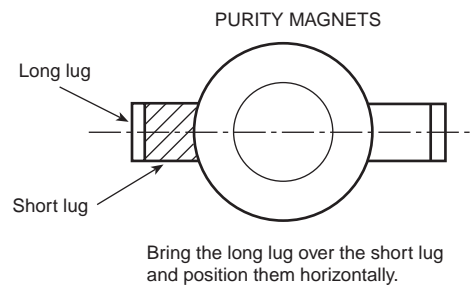

Fig. 2

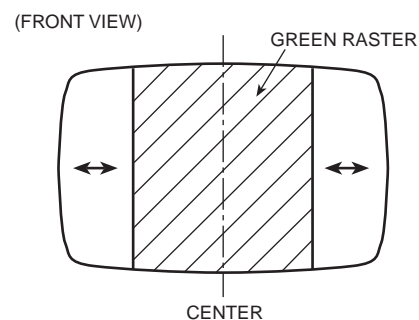

Fig. 3



**STATIC CONVERGENCE ADJUSTMENT**

1. Input a cross-hatch signal.
2. Using 4-pole convergence magnets, overlap the red and blue lines in the center of the screen (Fig. 1) to turn them to magenta (red/blue).
3. Using 6-pole convergence magnets, overlap the magenta (red/blue) and green lines in the center of the screen to turn them to white.
4. Repeat 2 and 3 above, and make best convergence.

**DYNAMIC CONVERGENCE ADJUSTMENT**

1. Move the deflection yoke up and down and overlap the lines in the periphery. (Fig. 2)
2. Move the deflection yoke left to right and overlap the lines in the periphery. (Fig. 3)
3. Repeat 1 and 2 above, and make best convergence.

- After adjustment, fix the wedge at the original position. Fasten the retainer screw of the deflection yoke. Fix the 6 magnets with glue.

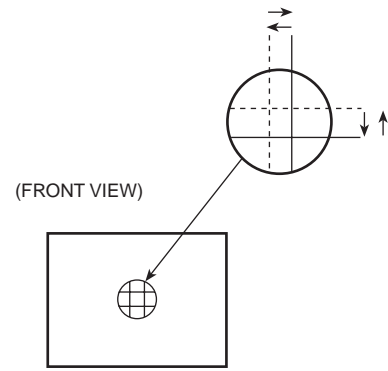

**Fig. 1**

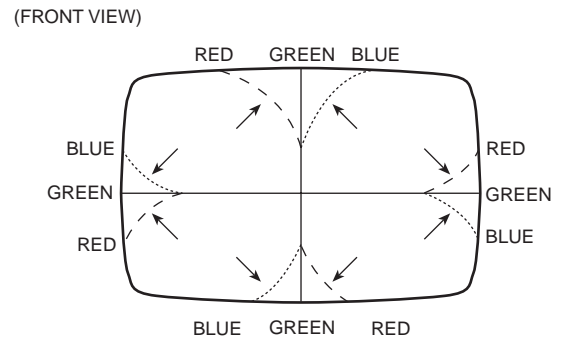

**Fig. 2**

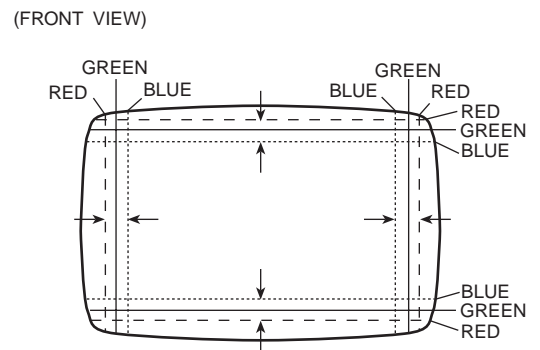

**Fig. 3**

## SELF-CHECK FUNCTIONS

### 1. Outline

This model has self-check functions given below. When an abnormality has been detected, the SUB POWER is turned off and the ON TIMER LED flashes to inform of the failure. An abnormality is detected by the signal input state of the control line connected to the microcomputer.

### 2. Self-check items

Check item	Details of detection	Method of detection	State of abnormality
Over-current protection	An over-current on the low B line is detected.	The main microcomputer detects the possible abnormality at 30-msec. intervals and judges the results in every 16 time. Of the 16 times, if NG is detected more than 9 times, it is judged that there is an abnormality.	When an abnormality has been detected, the SUB-POWER is turned off. While the SUB-POWER is being turned off, the POWER key on the remote control unit is not operational until the power cord is taken out and put in again.
CRT NECK protection	Operation of CRT NECK protection circuit	DITTO	DITTO

### 3. Self-check indicating function

At about 3 seconds after the power is turned on, the self-check function starts.

In the case where an abnormality has been detected within the subsequent 2 seconds, the ON TIMER LED flashes, but the SUB-POWER will be turned on when the elapsed time after power on reaches 5 seconds.

When an abnormality has been detected at about 5 seconds after power on, the ON TIMER LED flashes, and then the SUB POWER will be turned off immediately.

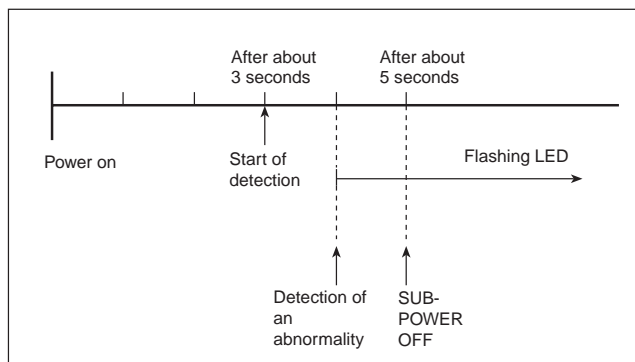

### [ Indication by the LED ]

Item	ON TIMER LED flashing intervals	Priority of detection
① Over-current protection	At 0.25-second intervals	1
② CRT NECK protection	At 0.5-second intervals	2

**Note:** In case of ① + ②, the item ① is indicated.



# JVC

VICTOR COMPANY OF JAPAN, LIMITED  
TELEVISION RECEIVER DIVISION 1106 Heta, Iwai-city, Ibaraki-prefecture, 306-0698, Japan

